

THIS DOCUMENT AND THE INFORMATION IT CONTAINS ARE PROPERTY OF EFFILUX AND CONFIDENTIAL. THEY SHALL NOT BE REPRODUCED NOR DISCLOSED TO ANY PERSON EXCEPT TO THOSE HAVING A NEED TO KNOW THEM WITHOUT PRIOR WRITTEN CONSENT OF EFFILUX

CE DOCUMENT ET LES INFORMATIONS QU'IL CONTIENT SONT CONFIDENTIELS ET SONT LA PROPRIETE EXCLUSIVE DE EFFILUX. ILS NE DOIVENT ETRE COMMUNIQUEES QU' AUX PERSONNES AYANT A EN CONNAITRE ET NE PEUVENT ETRE REPRODUITS NI DIVULGUES A TOUTE AUTRE PERSONNE SANS AUTORISATION PREALABLE ECRITE PAR EFFILUX

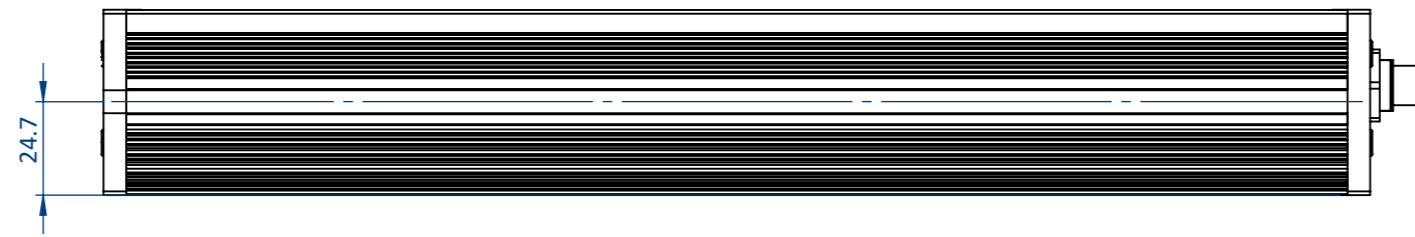

M12 OR M12P DEPENDING ON POWER CONSUMPTION. REFER TO THE DATASHEET

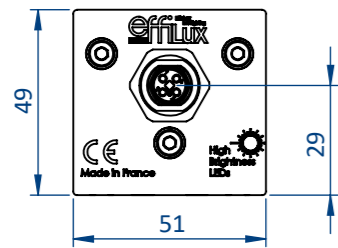
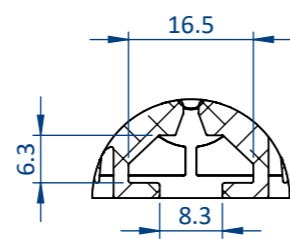
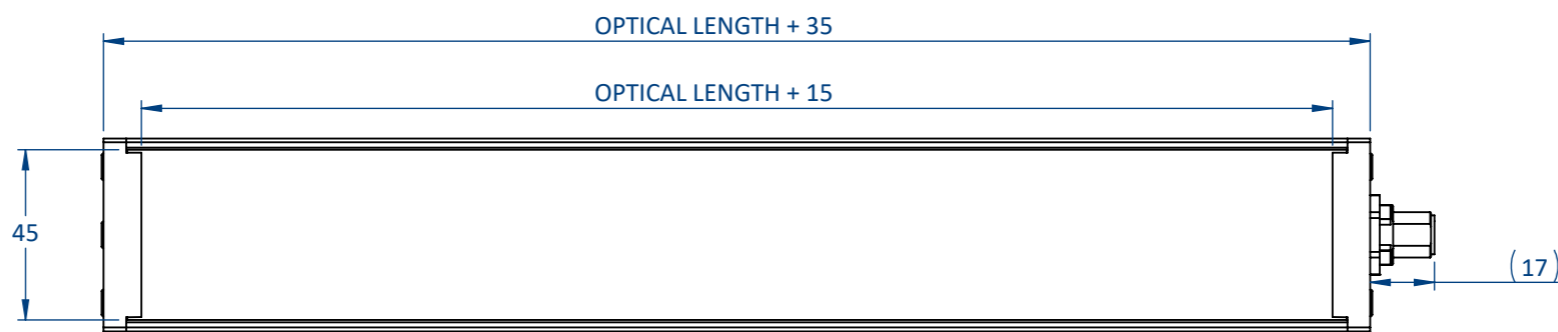
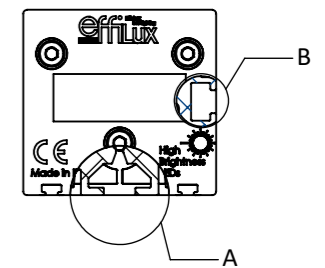

DETAIL A
SCALE 1 : 1
MOUNTING: T-NUT 8MM SLOT, M6

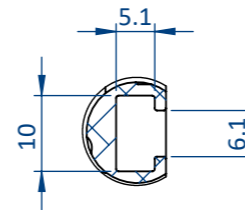

DETAIL B
SCALE 1 : 1
MOUNTING : NUT M6

OPTICAL LENGTH	PRODUCT LENGTH	WEIGHT (KG)
100	135	0,4
200	235	0,6
300	335	0,9
400	435	1,2
500	535	1,5
...
2800	2835	7,9
2900	2935	8,2

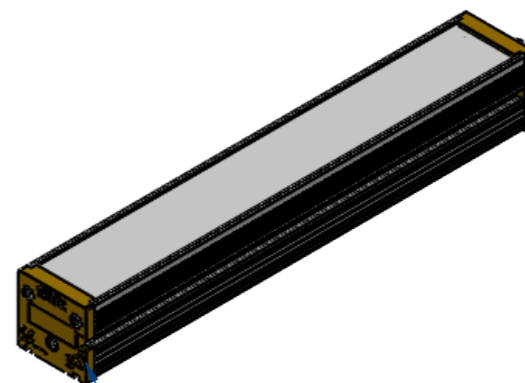

ALWAYS OPEN THE PRODUCT FROM THIS SIDE

PLEASE REFER TO THE SPECIFIC DOCUMENTATION FOR WIRING LAYOUT

Reference STANDARD EFFI-FLEX-BL		IP 5X	1 Rue de Terre Neuve Mini Parc du Verger Bâtiment E 91940 Les Ulis, France	
Designation EFFI-FLEX-BL-XXX-ZZZ		Mail: sales@effilux.fr Tel : +33 9 72 52 70 03 www.effilux.com		
Revision /	Date 22/04/2024	Unit : mm	General tolerances	
Scale 1:2	Size A3	Page 1/1	ISO 2768 - fH-E	

